

1. General

1.1 Overview

Thank you for selecting the **MX-600** E1/T1 over IP/Ethernet product designed and made by Changzhou Bell Data Communication Equipments Co.,LTd.. The product can be used to provide E1/T1 communication channels over Ethernet or IP networks.

The **MX-600** has many optional parameters, which can be modified by the user to suite different application requirements. Please read this manual carefully before installing the product.

It is well known that the E1 signal comes from PCM technology which is TDM in nature. It transmits information in a constant bit rate of E1_2048kbit/s, TDM technology occupies fixed transmission bandwidth, with QoS features suitable for real-time applications such as voice and video. The QoS features include short and stable transmission delay, low jitter and wander, etc.

On the other hand, Ethernet is based on statistical multiplexing, transmitting and exchanging information in packets. It does not take up a fixed transmission bandwidth, which is good for achieving higher bandwidth utilization. But Ethernet technology does not provide adequate QoS for real time applications.

Until recently, voice and data were, and still are to a large extent, transported over two separate networks. But the requirement for both types of information to be carried over a unified network is growing rapid. Packets over SONET/SDH techniques to integrate date into the TDM network have been around for many years. But for voice over packet based data networks, most of the efforts are spent on creating special equipment that packets voice or video signals, such as VoIP techniques.

However, to take advantage of the data network, it is neither cost effective, nor necessary to hastily replace all the TDM based equipment with new packet based equipment. The **MX-600** can be used to emulate transparent E1 channels over an Ethernet with adequate QoS, so that most of the existing E1based applications can be readily setup over Ethernet LANs and WANs. One particular suited application is to build E1 links with low cost wireless LAN bridges, replacing much more costly microwave radios.

MX-600 Features

- Provide 16 channels of E1/T1 over 1 Ethernet.
 - Provide 5 GE electrical ports and 1 GE optical port, 6 GE ports serve as network uplinks or users ports, Anyone of 5 GE electrical ports may act as NM
-

port

- Support Ethernet spanning tree protocol which enable normal work and protection in ring and mesh topology, protection resume in short time
- User-friendly Web server supported for easy setup and maintenance, alarm log provided
- Support SNMP V1/V2 network management
- Ethernet built-in layer 2 switch, support VLAN, comply with IEEE 802.3Q and 802.3ad, support 802.1P.
- Provide two pluggable E1 cards, each card supports 8 E1/T1s
- Point to point and point to multipoint application
- Stable E1 clock recovery, low jitter and wander
- Low processing delay for E1 channels, high bandwidth usage efficiency
- Resist to packet loss, with PCM frame synchronization protection
- User definable encapsulation packet size for different application
- Support Ethernet encapsulation and UDP/IP protocol encapsulation.
- Support VLAN settings for E1 service and in band VLAN management.
- Enough jitter buffer to resist packet delay variation (PDV)
- Local Ethernet port throughput limiting, assuring E1 QoS
- 120 Ω balanced E1/T1 port, RJ-45 connector, support 75 Ω unbalanced port through outside converting cable.
- Support cascade concatenate for more than 16 E1 ports
- Software and hardware online upgrade
- Power supply redundancy
- POE power supply supported by power module with 220V AC input and 55V DC output.

1.2 Applications

MX-600 is used to setup 1~16 transparent E1/T1 channels over LAN or IP networks, as depicted in Fig. 1.2-1.

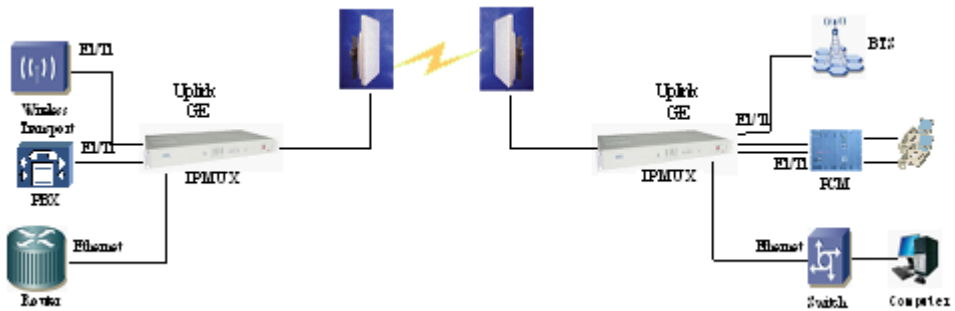

(a) Application in wireless network

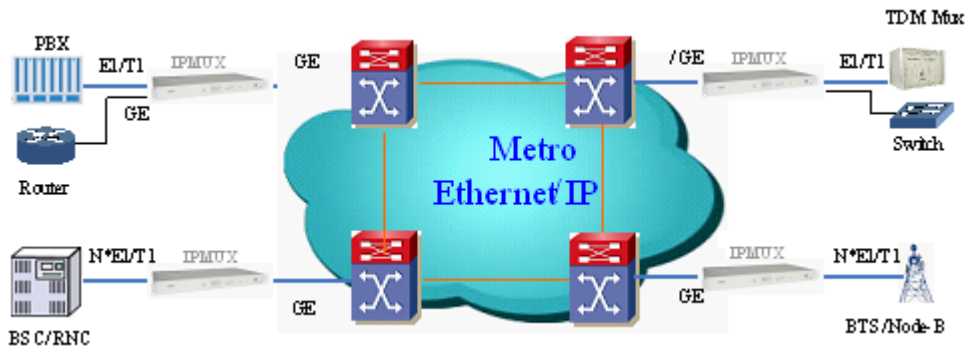

(b) Application in wired network

Fig. 1.2-1 MX-600 typical application

In the figure, a pair of MX-600 create transparent 1~16 E1/T1 channels over the packet network, providing connections between the PBX and telephone exchange, or other terminal devices. At the same time, computers talk to each other through the local Ethernet ports on the MX-600 s. This configuration guarantees that the E1 channels get higher priority over computer data for maximum QoS.

The most widely used application of MX-600 is to set up point to point wireless E1/T1 links using low cost wireless LAN bridges. MX-600 can work with most LAN bridges on the market. It may be necessary to adjust different parameters such as packet size and packet jitter absorption buffer size for best operation for different LAN bridges.

Be aware that wireless LAN bridges have a very limited bandwidth. If Ethernet data is to be transferred at the same time, its traffic must be restricted. Otherwise it will affect the E1/T1 packets. Since the LAN bridges usually don't have adequate QoS mechanism to guarantee the E1/T1 priority, it is strongly recommended that the data traffic be routed through the MX-600 local data port.



WARNING: When connecting to a wireless LAN bridge, the uplink Ethernet cable often connects to the outdoor unit, posing danger to lightning strikes that can seriously damage the equipment. To protect the equipment as well as people, surge protection devices with good earth connection is strongly recommended. Poor earth connection may also hinder the operation of the Ethernet port, causing severe packet losses.

1.3 Timing modes

To emulate a clear E1/T1 channel over a packet network, the **MX-600** not only conveys data stream content correctly from the source to the destination, but also passes timing. Packet networks do not provide such built-in timing transparency mechanism as TDM networks do. **MX-600** uses its proprietary algorithm to reconstruct the E1/T1 clock at the destination. The recovered clock is of very high quality, with low jitter and wander. Typical frequency offset is within $\pm 5\text{ppm}$, and jitter is below 0.1UI. It can be adopted in most applications. This timing mode of rebuilding the E1 clock at the destination is called Adaptive Timing.

For applications where separate clock distribution network exists, another timing mode, Loop back Timing, may be used for maximum clock quality.

The two timing modes of **MX-600** are depicted in Fig.1.3-1.

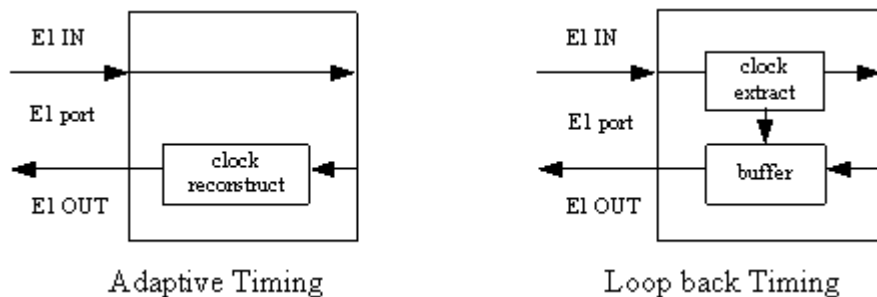

Fig.1.4-1 E1Timing modes

Correct timing mode setting is important for smooth operations. In most cases, setting both units to adaptive timing mode is sufficient. But sometimes, setting one unit to loop timing mode may work better. For example, setting the **MX-600** unit connected with the clock master (such as local exchange) to loop back mode, and the other unit connected with the clock slave (such as PBX or remote module) to adaptive mode, is probably better than setting both to adaptive modes.

One typical error in telecom applications is to connect two communication devices that are both clock slaves. Neither will **MX-600** support such operation no matter how the timing modes are set.



Note: that the E1 channel emulation takes several minutes to stabilize. During that period, clock drift may exceed the limit, errors and slips may

occur.

Various timing schemes are listed in Table 1.3-1, for applications depicted in Fig.1.3-2.

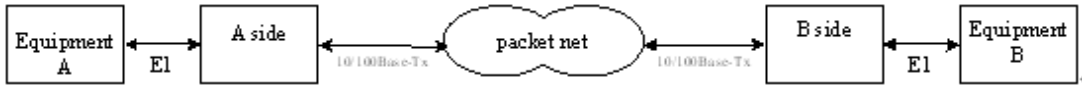

Fig.1.4-2 Timing mode scheme reference diagram

Table 1.4-1 Timing mode schemes

Equipment A clock mode	Equipment B clock mode	A side MX-600 Timing mode	B side MX-600 Timing mode	Note
		loop back	loop back	
master	master	adaptive	adaptive	Equipment A & B clocks plesiochronous
master	master	adaptive	adaptive	Equipment A & B clocks plesiochronous
master	slave	loop back	adaptive	
master	slave	adaptive	adaptive	
slave	master	adaptive	loop back	
slave	master	adaptive	adaptive	
slave	slave			Not allowed

Note that setting both units to adaptive timing mode works well for all the conditions, although the other option may work better.

2. System Architecture

2.1 Block diagram

The internal functional structure of MX-600 is depicted below:

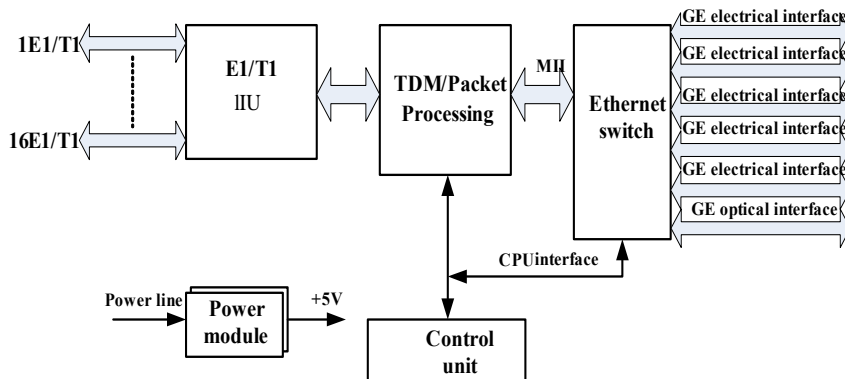

Fig. 2.1-1 Functional diagram



Fig. 2.4-2 Rear panel of MX-600

2.4.2 LED's

MX-600 LED indicators definition is as below table:

Table 2.4-1 LED indicators definition

LED	Color	Definition	Explanation	LED
SYS	G	1	System working state indication Blink: normal On: configuring or failure Off: not working or failure	
PWR FAIL	R	2	Power failure indication On: Power Off / Failure Off: normal	Every power card has 1 indicator
LINK	G	1	Ethernet optical interface connection status indication On: connected with remote optical interface Off: disconnected with remote optical interface	Ethernet optical interface indicator
OLOS	R	1	Ethernet optical interface receiving status indication On: receiving failure Off: normal	
LINK	G	5	Ethernet electrical interface status indication On: Link Blink: Data Off: Inactive	Each Ethernet port has 1 Link indicator
SPD	G	5	Ethernet electrical interface speed indication On: 1000M Off: 100M or 10M	Each Ethernet port has 1 SPD indicator
E1/T1 1~8	R	8	E1/T1 interface indication Various states are depending on dip switch states, details as Table 2.4-2.	Each E1/T1 card has 8 indicators

2.4.3 Dip Switches Definition

There are four Dip Switches on the front panel, the definition show as Table 2.3.1-1.

Table 2.3.3-1 Dip Switches Definition

Dip number	Label	State	E1/T1 card indicators definition	Note
1 st	LED_MODE	ON	E1/T1 packet loss alarm indication On: Ethernet interface can not receive E1/T1 Blink: Ethernet interface has packet loss Off: Ethernet interface has E1/T1 packet loss Blink: normal	Only when the 2 nd dip switch is set OFF, this dip settings will be valid.
		OFF	E1/T1 signal alarm status indication On: E1/T1 interface signal loss Blink: E1/T1 interface AIS alarm Off: normal	
2 nd		ON	Remote equipment link status indication On: addressing remote MAC Off: not addressing remote MAC	
		OFF	Set accord to the 1 st dip switch	
3 rd	NO_VLAN	ON	Software VLAN set disabled	It could be used when VLAN list is configured wrongly, leading to management can not work
		OFF	Software VLAN set valid	
4 th	TMP_IP	ON	Default IP address 192.192.192.192	
		OFF	Manually set IP address	

2.4.4 E1 Port

There are 8~16 E1 ports on the rear panel by configuring 1~2 E1/T1 cards. The E1 ports impedance are E1-120Ω for twisted pair cables or 75Ω for coax. The E1-120Ω RJ45 sockets are default for ports.

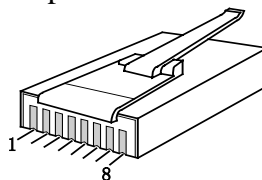

Fig 2.4.3 RJ45 connector pin sequence

Table 2.4.3 RJ45 120Ω-E1signal definition

RJ45 pins	E1/T1 signal	Twisted pair	Recommendation color
-----------	--------------	--------------	----------------------

1	IN (1) -	Pair	Blue
2	IN (1) +		Blue white
3	OUT (1) +	Pair	Orange
4	OUT (1) -		Orange white
5	IN (2) -	Pair	Green
6	IN (2) +		Green white
7	OUT (2) +	Pair	Brown
8	OUT (2) -		Brown white

2.4.5 Ethernet ports

There are five RJ45 Gigabit Ethernet electrical ports and one Gigabit optical port on the rear panel. Ethernet built-in layer-2 switch function. Supporting VLAN setting based on 802.1Q or 802.1ad Q in Q, and VLAN priority settings. The 6 GE ports could realize Ethernet switching function. Anyone of them can be used for uplink or local data transport, or anyone of GE electrical port could be used for NMS port.

GE electrical port adopts RJ45 socket, RJ45 Ethernet socket is defined as Table 2.4-4. Ethernet optical port uses LC connector, depending on different transmission distance, different SFP optical module could be selected. The port labeled (→ is for optical signal output, (← for input.

Table 2.4-4-1 RJ45 socket definition

Pin	1	2	3	4	5	6	7	8
Definition	TxD+	TxD-	RxD+			RxD-		



Note: 10/100Base-Tx interface has HP auto-MDIX function and it can check the transmission and receiving sequence and make configuration. So both MDI and MDI-X interfaces are supported and both cross line and direct line can be selected.

2.4.6 Power

Three power options are available, ~220V AC, -48V DC or dual power supply. It should be specified at the time of purchase.

3. Installation

3.1 Mechanical

MX-600 can be placed at the table top or mounted on a 19" rack. If it is to be mounted on the rack, the four (4) 10mm-high stands should be removed with a screw driver.

The mechanical dimensions of **MX-600** are given in Fig.3.1-1.

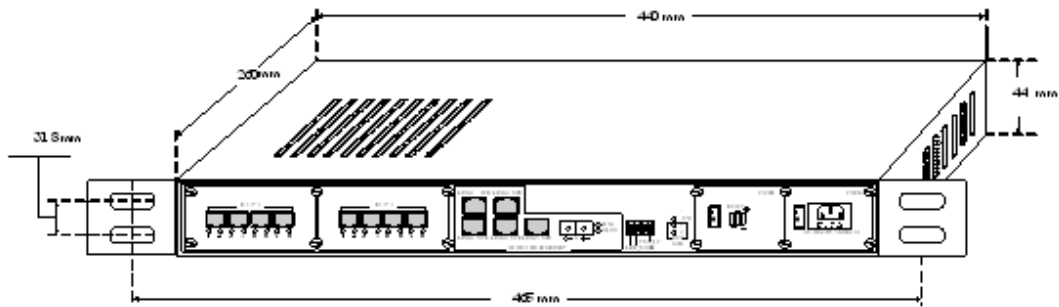

Fig.3.1-1 Mechanical dimensions

3.2 Electrical

3.2.1 Power connection

The **MX-600** consumes less than 10W of power.

According to power option, -48V DC or 220V (110V) AC or dual power supply, select the right power supply for the equipment. For the -48V type, connect -48 supply to the power connector -48V port, and ground to the other port. The screws on the power connector must be tightly fastened. For ~220V equipment, connect the device to the ~220V outlet with standard power cord supplied with the equipment. Note that there is a 1A fuse in the ~220V socket which may be replaced when burned. The -48V equipment uses PPTC resettable fuse, no customer replacement is required.

It is recommended to turn off the power switch before connecting or disconnecting the power.

On the left corner of rear panel, a screw is used for connecting the chassis to the protective ground. Be sure to make this connection using a thick wire.



WARNING: The system must be securely connected to a good protective ground for safety. All interconnected equipment must be grounded for maintaining signal integrity as well. Ground potential may also damage the interface ports.



WARNING: To avoid electric shock, the ~220V outlet must have good ground.

3.2.2 E1/T1 connections

The E1/T1 ports on **MX-600** are used for connecting to E1 equipment such as the telephone exchange or PCM terminals.

8/16 E1/T1 Ports Supported. E1 ports impedance are E1-120Ω for twisted pair cables or 75Ω for coax. **The E1-120Ω RJ45 sockets are default for ports.**

The E1-120Ω connection cable is made with RJ45 connectors and a length of 4-pair twisted cable. The cable is not provided with the equipment, and the user is responsible for making such cables in the field with length suitable for a particular installation. The signal definition is given in Table 3.2.2-1, and pin order is depicted in Fig. 3.2.2-1. Note that pin-1 and pin-2 should use the same twisted pair, so should pin-4 and pin-5.

E1 service can set the actual service quantity by NMS, set the exact E1 channels received by local equipment from remote equipment, realizing E1 service one point to multi-point unidirectional transmission function.

By NMS, E1 ports provide local loop back and remote loop back, 8 E1 ports loop back can be set independently, and by the dip RA on front panel E1 indicators can be controlled to indicate local or remote ports LOS and AIS status. The local and remote loop back definition is shown as Fig 3.2.2-3:

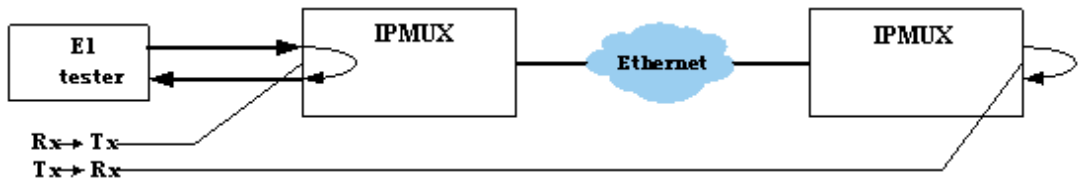

Fig 3.2.2-3 E1 loop back

Rx→Tx can test E1 connection cable, and Tx→ Rx is used to test the whole circuit including MX-600 in the two ends and the link between them.

3.2.3 Ethernet/optic fiber connection

MX-600 provides 5 standard RJ45 Ethernet interface and a LC optical interface for connection with the transmission network, such as wireless Ethernet bridge interface; or access to a local Ethernet port, such as switch and so on. Any Ethernet electrical interfaces can be used for Web Server or SNMP management and device software and hardware upgrades.

Ethernet Optical adopts SFP integrated optical modules, marked with (→ for the optical signal input. marked with (← for the optical signal output. Optic fiber access though patch cord. Connect the plug socket when the optical module should be made to plug into the socket pin on the positioning of the corresponding gaps, and plug in place. Patch cord bending radius is no less than 50mm. Plug optical connector, not directly pulling fiber. Please keep the socket on the SFP protection plug, no plug inserted optical fiber, be sure to protect plugs, prevent dust entering.



Note: 1. This equipment Ethernet electrical interface with the HP auto-MDIX feature that automatically detect network cable transmitting/receiving sequence and then adapting, both of MDI and MDI-X Ethernet interface, both crossover cable or straight cable can be used.

2. Uplink interface connect with the Ethernet interface of wireless bridge we need to use straight cable.



Warning: When connecting to a wireless LAN bridge, the uplink Ethernet cable often connects to the outdoor unit, posing danger to lightning strikes that can seriously damage the equipment. To protect the equipment as well as people, surge protection devices with good earth connection is strongly recommended. Poor earth connection may also hinder the operation of the Ethernet port, causing severe packet losses.

4. **Troubleshooting**

This paragraph describes common mistakes and faults that may occur during installation and maintenance. Please seek support from Changzhou Bell Data Communication Equipments Co.,LTd. for other problems.

4.1 **E1/T1 Alarms LED on**

There are two groups of LEDs, PKT LOS and LOS for E1 alarms LEDs.

When E1 LOS LED is on, loss of E1 signal fault is detected by EthMux. Possible causes include:

- The downstream equipment such as telephone exchange or PCM terminal is powered off.
- The E1 cable connection looses or broken.

E1/T1 LOS LED blinks when respective input E1 signal is AIS, i.e. the content of E1 data is all 1's. Such alarm indicates fault conditions on the part of the downstream equipment.

E1/T1 LOS site is controlled by Dip Switch RA state. When RA Dip Switch ON, the red LEDs indicate **remote** E1 LOS state. When RA Dip Switch OFF, the red LEDs indicate **local** E1 LOS state.

The E1 PKT LOS lights are packet loss indicator, On for Ethernet packet loss, Blink for E1 Packet Loss, Off for Normal.

4.2 **Lnk/Act LED off**

Lnk/Act LED off means the corresponding Ethernet link is not working. Check the Ethernet cable connection, and the status of the device on the other end of the cable.

4.3 **Ready LED does not blink**

After power on, the Ready LED should start to blink. If not, try switch power off and on again. If this error persists, call for support.

4.4 Cannot set up E1channel

4.4.1 Same LAN domain

When two **MX-600** s are within the same Ethernet broadcast domain, try following.

Check if the transmission network is on.

Check that the network will pass broadcast packets. For a network that suppresses broadcast packets, as some of the wireless LAN bridges do, disable ARP and manually setup local and remote MAC's.

Check that there is no MAC address conflict on the LAN.

Check that the transmission network has enough bandwidth (more than 2.5Mbps duplex).

4.4.2 Different LAN domain

When two **MX-600** s are in different Ethernet broadcast domains, IP headers must be used, and packets will be routed by a gateway router, try following.

Check if the default gateway IP is defined correctly.

Check if the local and remote IP is set correctly.

Check for any conflicts in IP or MAC addresses.

Make sure the transmission network has enough bandwidth.

4.5 Downstream reporting slips

Check if the downstream equipment has correct clock mode. At least one of them must be clock master. Set the EthMux on master side to loop back timing.

If the downstream equipment on both sides is not synchronized, slips are not avoidable.

At the transition time after power on or reapplying the E1signal, slips and errors are acceptable. Such transition may take several minutes.

5. Web Manager

Both Web Server and SNMP management are supported through anyone of two user data ports of V-IPMUXV16.

The management has three sections: Status, Configuration and System. User name and password are required to enter the sections of Line Test Configuration and system. Both the default user name and password are "admin". Customers can modify the user name and password in the System section.

Following will introduce the Web Server Management of **MX-600**

5.1 Show current status menu

After input the IP address, status information of **MX-600** will be displayed

such as hardware version, software version, IP address, subnet mask, gateway address and MAC address. IP address, subnet mask and gateway address could be changed manually, but hardware/software version and MAC address only could be inquired but not changed. Details are shown in fig.5.1-1.

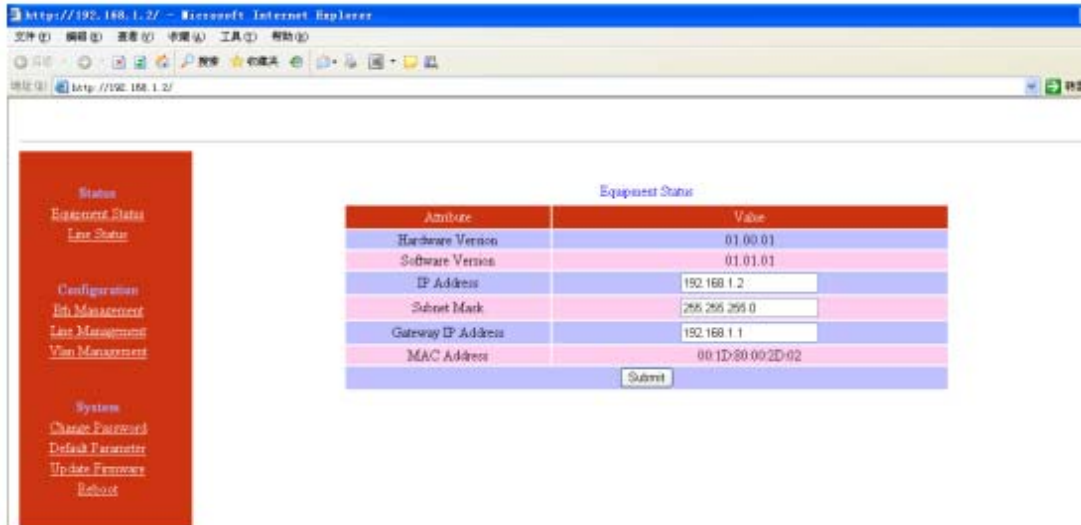

Fig5.1-1 Status Menu

Click left Line status will bring line status interface, including current E1/T1 signal LOS, AIS alarm, loopback setting state and power failure indication. These alarm information could be masked in Alarm Mask, if the mask is set, corresponding alarms in LED indicators and SNMP management will be masked. At the same time, E1/T1 loopback settings state will be displayed. E1/T1 loopback could be used for line test, definition as section 3.2.2. E1/T1 loopback setting only submit will valid, but loopback settings will not be saved, that is, when reboot the equipment, each channel of E1/T1 will under non-loopback state. See detail as 5.1-2.

Line Status		Port	Service No.	Alarm	Loopback	Alarm Mask
1	e101 chnl 01			LOS	Rs->Te	<input type="checkbox"/>
2	e101 chnl 02			LOS	None	<input type="checkbox"/>
3	e101 chnl 03			LOS	Tr->Fr	<input type="checkbox"/>
4	e101 chnl 04			LOS	None	<input type="checkbox"/>
5	e101 chnl 05			LOS	None	<input type="checkbox"/>
6	e101 chnl 06			LOS	None	<input type="checkbox"/>
7	e101 chnl 07			LOS	None	<input type="checkbox"/>
8	e101 chnl 08			LOS	None	<input type="checkbox"/>
9	e101 chnl 09			LOS	None	<input type="checkbox"/>
10	e101 chnl 10			LOS	None	<input type="checkbox"/>
11	e101 chnl 11			LOS	None	<input type="checkbox"/>
12	e101 chnl 12			LOS	None	<input type="checkbox"/>
13	e101 chnl 13			LOS	None	<input type="checkbox"/>
14	e101 chnl 14			LOS	None	<input type="checkbox"/>
15	e101 chnl 15			LOS	None	<input type="checkbox"/>
16	e101 chnl 16			LOS	None	<input type="checkbox"/>

Power Status			Power	Alarm	Alarm Mask
1				Fail	<input type="checkbox"/>
2					<input type="checkbox"/>

Fig.5.1-2 E1 Line Status Information

5.2 Configuration

5.2.1 Service configuration and parameters instruction

This section includes VLAN management, Ethernet Management and Line Management. Every section has many parameters setting. As Fig.5.2-1.

Ethernet Management		Port	Service No.	Link	Speed	Duplex	Mode	Alarm Mask
1	eth port 01			UP	1000 Mbps	FULL	Auto	<input type="checkbox"/>
2	eth port 02			DOWN	---	---	100 Full	<input type="checkbox"/>
3	eth port 03			DOWN	---	---	10 Full	<input type="checkbox"/>
4	eth port 04			DOWN	---	---	Auto	<input type="checkbox"/>
5	eth port 05			UP	100 Mbps	FULL	Auto	<input type="checkbox"/>
6	eth fx port			DOWN	---	---	Auto	<input type="checkbox"/>

Fig.5.2-1 Ethernet Management

Table 5.3-3 Ethernet management parameters

Parameters		Options	Explanation
Eth Port	Port		6 Ethernet ports number

Parameters		Options	Explanation
Status	Service No.		Ethernet service No.: support at most 20 capital/small letters, digit and part special character input. Chinese character support 2 numbers(not support some special characters, as “ / ”、 “ \ ” input.
	Link		Link: indicate current Ethernet link(Up/Down)
	Speed		Speed 10/100/1000Mbps: indicate current Ethernet port speed
	Duplex		Duplex: indicate current Ethernet work mode (half/full)
	Mode	Auto 1000M full 100M full 100M 10M full 10M half	6 Ethernet ports work mode configuration: <u>Adaptive (default)</u> 1000M full 100M full 100M half 10M full 10M half Electrical interface work modes have Auto, 100M full, 100M half, 10M full and 10M half. Optical interface work modes have Auto, 1000M full, 100M full and 100M half
Alarm Mask		Set Ethernet interface alarm mask	

Note: The sentence with underline is default settings.



Fig

5.2-2 E1/T1 line management interface

E1/T1 service management parameters setting are given as below table:

Table 5.2-2 E1/T1 service management parameters

Parameters		Selections	Explanations
E1 Management	E1/T1	E1	E1 or T1 selected for all 16 channels of E1/T1, <u>Default: E1</u>
		T1	
	Encapsulation Level	1~5	E1 data size encapsulated in E1/T1, N=1~5 optional, corresponding to 256×N byte (E1) .The bigger the packet is the more data each packet encapsulated, the lower overhead it has. Bandwidth efficiency will be raised and delay will be increased. <u>Default :2</u>
	Use IP Encapsulation	Yes	<u>Yes: IP encapsulation, source and destination IP address should be set. Could pass router, Bandwidth efficiency will be reduced</u> No: do not use IP encapsulation, can not pass router, high bandwidth efficiency
		No	
	Port		16 E1/T1 ports
	Service No.		E1/T1 service No.: support at most 20 capital/small letters, digit and part special character input. Chinese character support 2 numbers(not support some special characters, as “/”、 “\” input.
	Enable		Enable the channel of E1/T1. <u>Default: Enable</u>
	Destination IP		Remote end IP address; 4 E1 line IP addresses can be set separately <u>Default 192.168.1.3</u>
	Timing Mode	Adaptive	<u>Adaptive mode:E1 timing from remote E1 stream;</u> Loop back mode:E1 timing from local E1 stream Local mode: E1/T1 timing from internal clock
		Loop back	
		Local	
	Jitter Buffer	2~120ms	Jitter absorption buffer: worked with the link with bigger jitter, used to buffer the receiving packets. Coming packets buffer to eliminate jitter. Range: 2~120ms. <u>Default 16ms</u>
Destination IP		Each E1/T1 connected equipment IP address, could be set respectively. <u>Default:192.168.1.3</u>	
From remote port		Select corresponding relation of local E1 ports to remote E1 port service.	

Note: The sentence with underline is default settings.



Fig 5.2-3 VLAN management interface(1) –VLAN configuration



Fig 5.2-4 VLAN management interface (2)- Ethernet port configuration

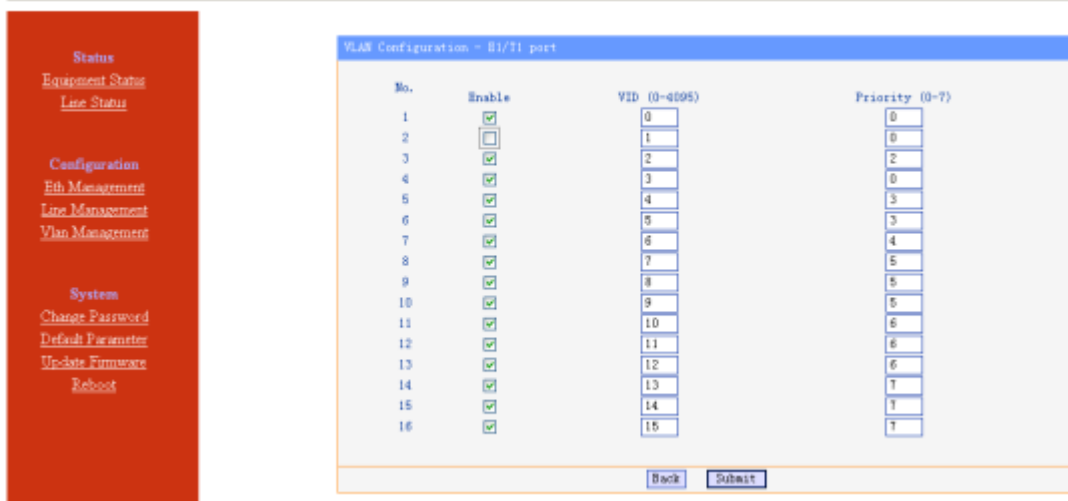

Fig 5.2-5 VLAN management interface (3)- E1/T1 port configuration



Fig 5.2-6 VLAN management interface(4)- VLAN table



Fig 5.2-7 VLAN management interface (5)-VLAN configuration confirm (click NEXT to enter)

Fig.5.3-2 VLAN management

Parameters		Selections	Explanation
VLAN Management	E1 VLAN Configuration	Enable VLAN	Yes: with VLAN tag, support the VLAN network with priority to guarantee E1 QoS; <u>(default)No: no VLAN tag</u>
		Priority	Define users priority, including 8 levels (0-7), the number is bigger, the priority is higher. <u>Default: 5</u>
		Van ID	VLAN identify section, support 4096 VLAN identity. Range (0-4095). <u>Default: 2662.</u>
Local Data VLAN Configuration	Data2	Add vlan tag in local Ethernet service packet, the selection is as E1 VLAN Configuration default: disable vlan, priority 0, valn ID:1	
	Data1/monitor		

Table 5.3-2 VLAN management parameters

Parameters	Options	Explanation	
VLAN Management	VLAN Mode (E1/T1)	802.1Q	802.1Q add VLAN tag on Ethernet frame.
		Q in Q	QinQ add operators VLAN (S-Tag) in 802.1Q. Realizing VLAN stack. Suit for the network with VLAN Priority, ensuring E1/T1 QoS.
	VLAN Mode (Ethernet)	Disable	Disable VLAN setting, there is no VLAN tag, suitable for network without VLAN priority;
		802.1Q	Enable 802.1Q VLAN or Q in Q, it will add VLAN tag or double VLAN tags in the front of Ethernet frame.
		Q in Q	Suitable for network with VLAN priority.
	Ethernet Port VLAN Configuration	Eth No.	Ethernet port number 1~7 1~6 is Data/Uplink port, 7 is internal trunk.
		VID	VLAN ID, support 4096 VLAN, ID, range (0-4095)
		Priority	Define customer priority, including 8 PRI degree(0-7), PRI is higher when this number is bigger.
	E1/T1Port VLAN Configuration	No.	E1/T1 port number 1~16
		Enable	After ticking off, customer could set E1/T1 VLAN VID and PRI; otherwise, E1/T1 VLAN VID and PRI will set as default port7.
		VID	VLAN ID, support 4096 VLAN, ID, range (0-4095)
		Priority	Define customer priority, including 8 PRI degree(0-7), PRI is higher when this number is bigger.
	VLAN Table		VLAN table configuration, inquiry, add and delete. Select: when add VLAN group or VLAN members, property configuration changed, this should be tick off. VID: VLAN group ID, support 0-4095 Mbr.: VLAN group member, it will be VLAN member when tick off Untag: tagged/untagged, ticking off means (untag)
	Next		Ethernet VLAN way, Ethernet port VLAN and VLAN table configuration confirm.

5.3.2 Service configuration indication

1. Bandwidth auto adaptation for E1/T1 depends on the connection of E1/T1 is enabled or disabled. It is suggested to disable this channel of E1/T1 when it is not used.

2. The MAC address of **MX-600** is fixed in the device. It is an only, fixed, and 12-hex MAC address, such as 80-80-80-80-80-80, then it could communicate with other equipments. **MX-600**'s MAC address is already fixed, no need to set again. ARP is supported and the remote end MAC address can be got through auto-negotiation. So it is unnecessary to set the MAC address for the remote end, but IP address is needed.



NOTE: Each device should have only one MAC address in the multicast area!

3. In order to improve the E1/T1 data transmission service quality, according to Ethernet provided transmission support IEEE 802.1Q and 802.1p or not, V-IPMUXV16 can set whether to add VLAN tag with priority in the encapsulate process. According to 802.1Q/802.1p standard to packing, the encapsulation overhead is bigger (more 4 bits is added in each Ethernet packet), but it also can be transmit according to priority level. But to the network which doesn't support 802.1p, it is no sense to set VLAN but increase unnecessary bandwidth, so here should set VLAN to Disable.

4. In order to avoid the management failure caused by configuring VLAN, it is not suggest to set VLAN tag for the managed VLAN members(tick off untag). Untag internal trunk also; if internal trunk tag is needed, it have to comply a rule as “ remote first”, that is to say, configure remote equipment VLAN table firstly, then configure VLAN table for the equipment connected with management PC. If management failure caused by configuring VLAN, set down dip3 to disable VLAN.

5.3 Network configuration

The system configuration includes network configuration, change password, default parameters settings, save parameters and reboot the equipment. The interfaces are shown as below:

5.3.1 Change the password

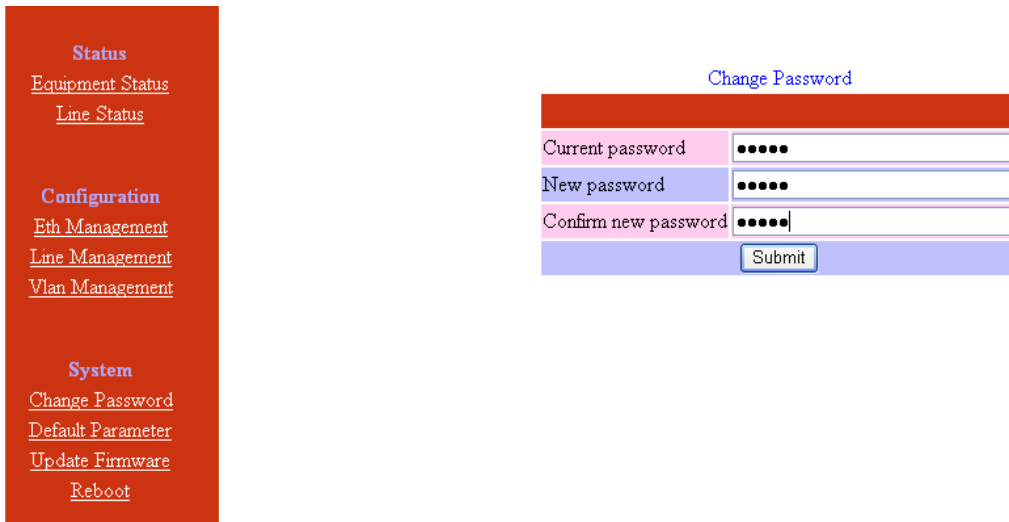

Fig 5.4-2 change the password

The change will be valid after confirm the submitting.

5.3.2 Default parameter recovery

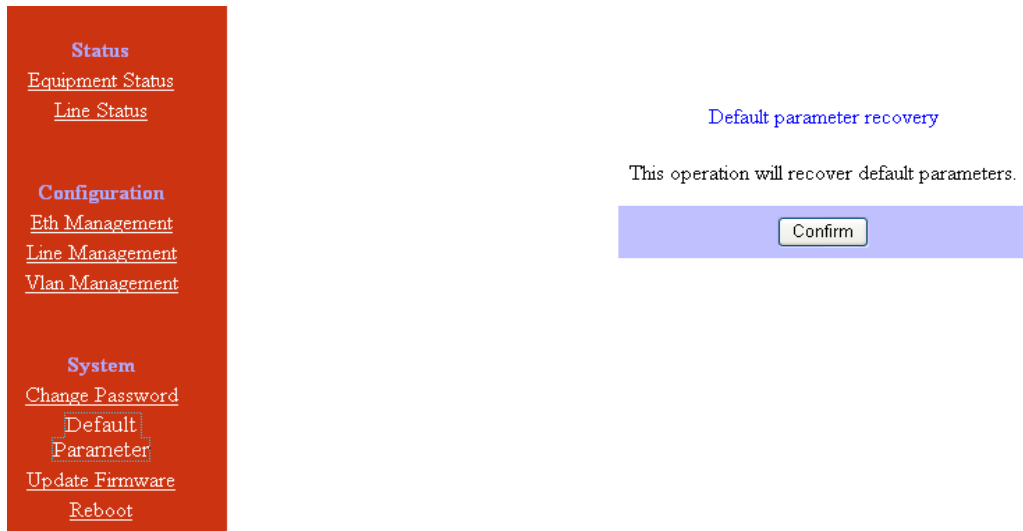

Fig 5.4-3 default parameters recovery 1

After recovering default parameters, it will show access failed, as below picture. Then default parameters already recovered, we need to restart Web Server.



Fig 5.4-4 default parameters recovery 2

Click Reboot to restart equipment, default parameters will be valid.

5.3.3 Upgrade online

By Webserver management, upgrade online need IE 6.0 version or above, if other versions of IE are using, please use FTP for upgrade. Following will introduce Webserver upgrade online operation.

Step 1: click Upload to get the new program file, as figure 5.3-4.

Note: hardware program file name is H-Patch, software program file name is S-patch, can not be changed.

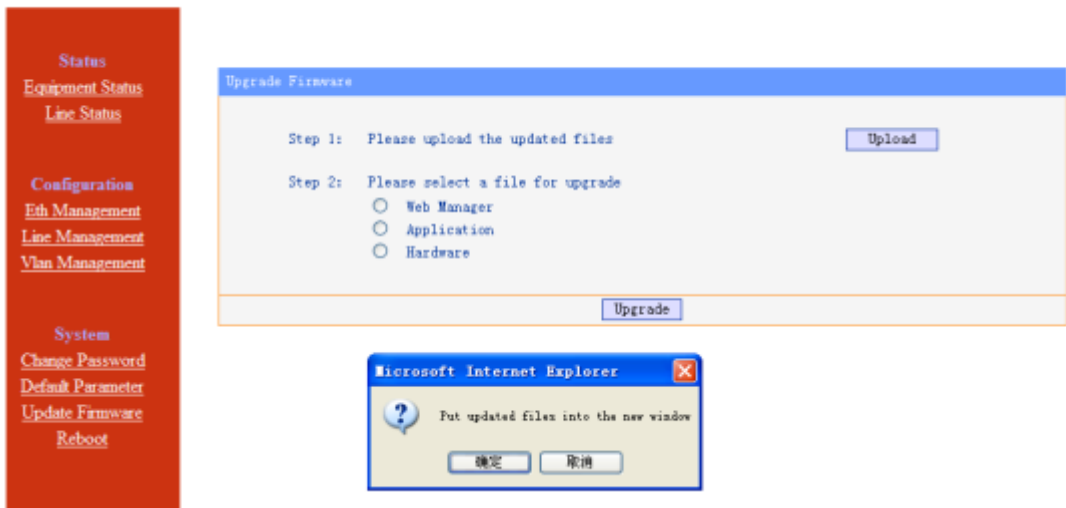

Fig 5.3-4 upgrade online 1—upload new program

Step 2: select program type, click Upgrade to start.

New program will be performed immediately when Web management software upgraded successfully; But we need to restart the equipment to perform the new program when application software is upgraded. Warm boot (reboot) or cold boot could (c be selected. Upgrade hardware program need longer time, and it need cold boot after upgrading.

(1) Upgrade Web management software.

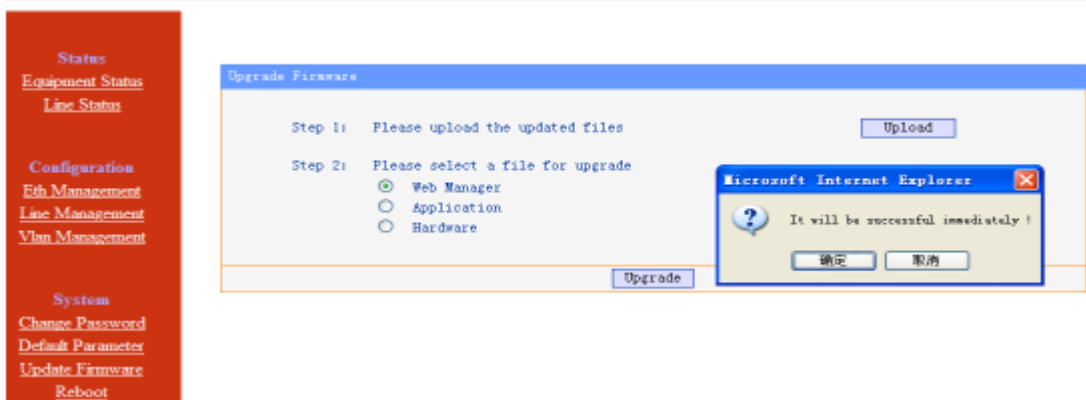

Fig 5.3-5 upgrade online (1)—select a file to upgrade

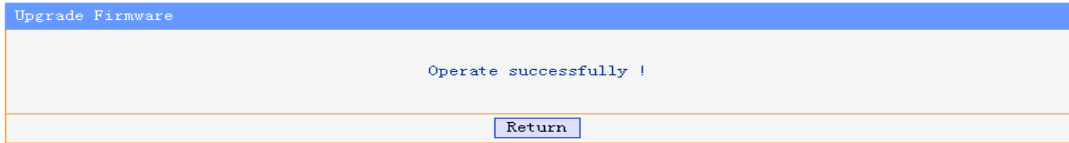

Fig 5.3-5 upgrade online (2)—operate successfully

(2) Upgrade application software.

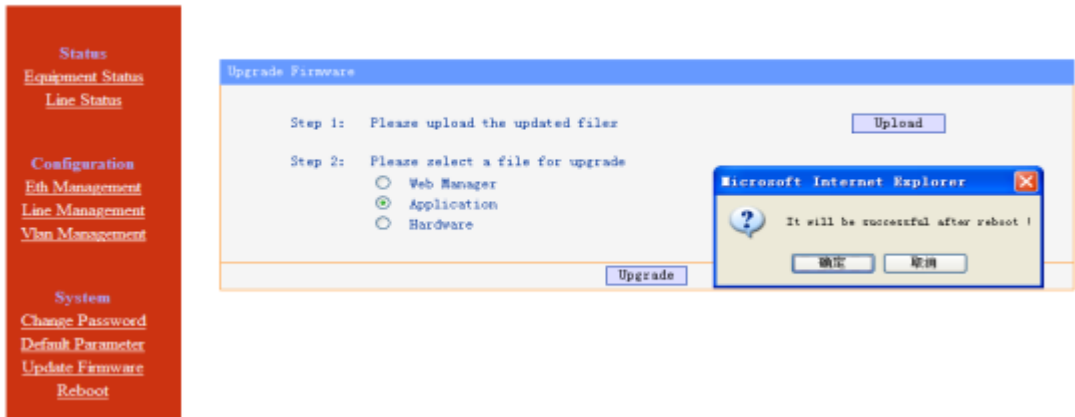

Fig 5.3-7 upgrade online (3)—select an application software file

After the upgrade, Internet Explorer cannot display the webpage, shown as below, it need to refresh the webpage, warm boot or cold boot equipment, new program will be valid.

(3) upgrade hardware program

Upgrade hardware program is dangerous operation, usually need longer time (at least 4 minutes), once power failed during upgrade period, equipment may not be started up again, in this case, we need rewrite program via download cable, which will make service configuration loss. Therefore, users should treat it carefully. Cold boot equipment, new program will be valid.

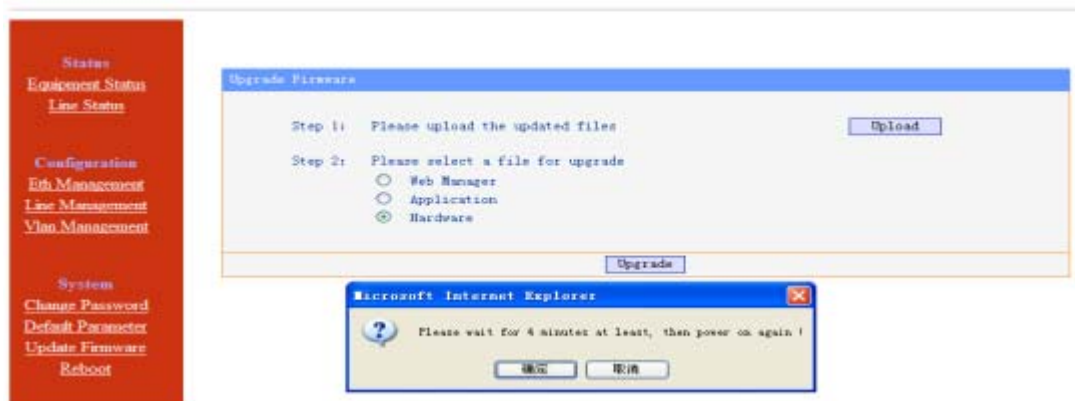

Fig 5.3-9 upgrade online (4)—select an hardware program file

Click option Hardware, it will pop out a progress bar window, as figure 5.3-10. If there is no this window popped out (check if the if IE set to stop pop windows), Internet Explorer cannot display the webpage, we have to wait 4 minutes later, then switch off equipment, otherwise, equipment may not be started up normally.

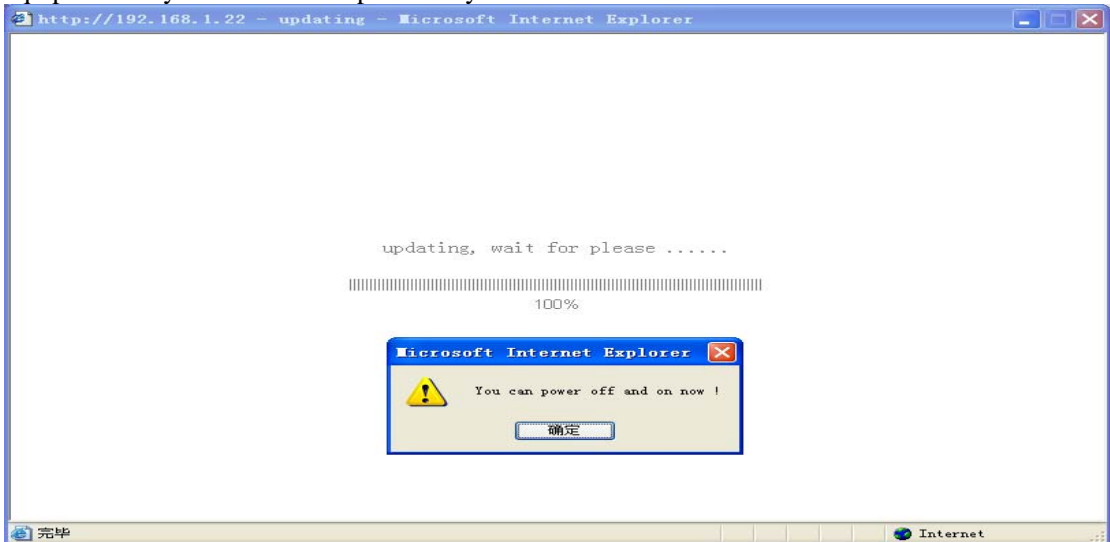

Fig 5.3-10 upgrade online (5)—operate successfully

5.3.4 Reboot system



Fig5.4-6 Reboot equipment

6. Specification

6.1 Capacity

It supports 8 or 16 E1 ports, 5 GE electrical ports and 1 GE optical port. 1

6.2 E1 interface

Comply with ITU-T G.703 recommendation

Eight E1 Ports Supported. E1 port impedance E1-120 Ω for twisted pair cables or 75 Ω for coax (The RJ45 E1-120 Ω are default for ports)

End-to-end delay (minimum delay setting) $\leq 10\text{ms}$

Output frequency offset (adaptive timing, stabilized) $\leq 5\text{ ppm}$

Output jitter (adaptive timing) $\leq 0.1\text{UI}$

6.3 10/100/1000Base-Tx port

Comply with IEEE 802.3, 802.1

10M/100M/1000M Adaptive

Half/Full Duplex Adaptive

Support 802.1Q MAC

Uplink ports 1+1 backup supported

Ethernet built-in layer 2 switch function. Support 802.1Q VLAN, 802.1ad Q in Q, 802.1p

6.4 Power

AC: 100V~260V/50Hz (fuse: 1A)

DC: -36V ~ -72V (optional) or dual power supply

Power Consumption: $\leq 9\text{W}$

6.5 Operating condition

Temperature: (0~45) $^{\circ}\text{C}$

Humidity: $\leq 90\%$ (non-condensing)

6.6 Dimensions

Width \times Height \times Depth: 440 \times 44 \times 260 mm

6.7 Weight

$\leq 3.5\text{ kg}$